

Product data sheet

Information

Designation	90° angled curtain rail, 1000 x 1000 mm, Chrome-plated steel tube
Reference	004145



Description

Chrome and nickel-plated steel tube \varnothing 16 x 0,5 mm.
Can be cut to size.
2 sliding wall flanges made of white ABS.

Wall fixings not included.

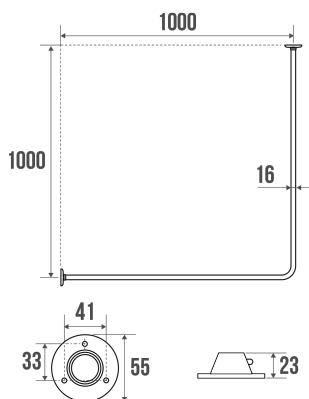

Technical characteristics

Finish	Chrome and nickel-plated
Dimensions	1000 x 1000 mm
Material	Steel
Gross weight	0.960 kg
Packaging	Plastic protection bag
Made in France	yes
Maintenance	yes
Guarantee	1 year
Gencod	3563390041451
Custom code	7324900010
Technical sheet	No technical sheet available
Spare parts	Ref. 004035, White ABS wall flange.

Fixing and maintenance advices

Careful consideration and selection of the appropriate wall fixings according to the wall-mounted support is required to ensure the long life of your accessory. The use of stainless steel screws (\varnothing 4 mm) is highly recommended to prevent corrosion in damp environment. Before drilling, physically hold the product against the wall at desired position and mark the hole locations. All the fixing points must be respected. After installation and before use, make sure that all fixing screws are tightened securely.



Fiche produit mise à jour le : 07/05/2024