

Product data sheet



Information

Designation	1200 mm straight section
Reference	041812

Product advantages

- + **Optimal gripping: elliptical tube.**
- + **Perfect for customized layouts ; even the largest ones : whether indoor or outdoor.**
- + **Many wall configurations are possible.**

Description

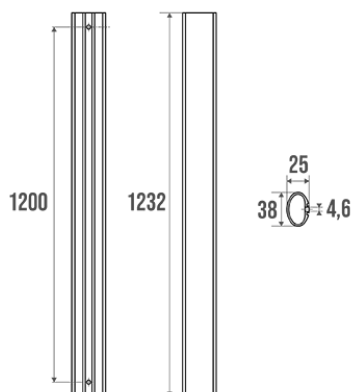

Elliptical tube in epoxy-coated aluminium 38 x 25 mm.
Can be cut: refer to the specific instructions.

Technical characteristics

Finish	Epoxy-coated
Color	White
Dimensions	1200 mm
Diameter Ø	38 x 25 mm
Material	Aluminum
Made in France	yes
Maintenance	yes
Guarantee	10 years
Net weight	0.720 kg
Gencod	3563390418123

Custom code

761520000

Technical sheet

[A04170000_IND_00](#)

Fixing and maintenance advices

Fits into the Arsis kit components.##To cut the section, please, refer to the technical document "Recoupe d'un profilé Kit Arsis", available for download.

Fiche produit mise à jour le : 07/05/2024