

Product data sheet

Information



Designation	Straight grab bar, 800 mm, White Polyalu, tube Ø 33 mm
Reference	046180

Product advantages

- + Invisible fasteners.
- + Anti-corrosion guarantee.

Description

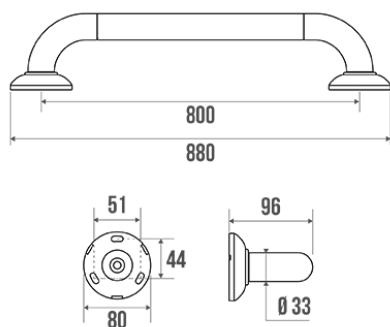

Composite material: White synthetic resin + aluminium profile. Tube Ø 33 mm.
White flange border and central body.
Concealed fixings.

Stainless steel fixing screws included.

Technical characteristics

Color	White
Dimensions	800 mm
Diameter Ø	33 mm
Material	Polyalu
Gross weight	0.990 kg
Packaging	Printed plastic protection bag
Maximum Weight Capacity	150 kg
Laboratory tests	225 kg
Made in France	yes
Maintenance	yes
Guarantee	10 years
Gencod	3563390461808
Custom code	7615200000

Technical sheet

[A55182801_IND_04](#)

Spare parts

Ref. 046100, Polyalu cover plate. Ref. 046101, Bag of 3 stainless steel screws. Ref. 046288, Flange, cover plate and fixings.

Fixing and maintenance advices

Recommended height for the horizontal part : 800 mm from the ground. Grab bars provide support and added safety if properly fitted in accordance with our technical instructions. Careful consideration and selection of the appropriate wall fixings according to the wall-mounted support is required to ensure the long life of your accessory. The use of stainless steel screws (\varnothing 4 mm) is highly recommended to prevent corrosion in damp environment. Before drilling, physically hold the product against the wall at desired position and mark the hole locations. All the fixing points must be respected. After installation and before use, make sure that all fixing screws are tightened securely. **DO NOT** use the grab bar as a step. **DO NOT** sit on or hang from the grab bar.

Fiche produit mise à jour le : 07/05/2024