

Product data sheet



Information

Designation	ERGOSOFT straight grab bar, 800 mm, White Polyalu, tube Ø 33 mm
Reference	046185

Product advantages

- + Non-slip and anti rotation grab bar.
- + Concealed fixings.
- + Corrosion resistant warranty.

Description

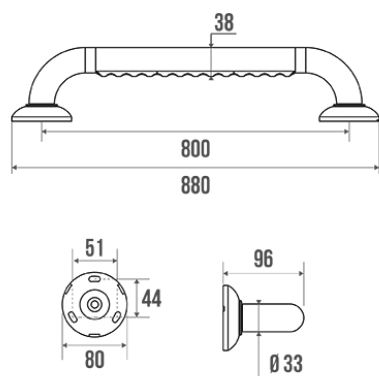

Ergonomic grab bar.
Composite material: White synthetic resin + aluminium profile + taupe ergonomic notch.
Tube Ø 33 mm.
White flange border and central body.
Non-slip and anti-rotation for the hand.

Stainless steel fixing screws included.

Technical characteristics

Color	White
Dimensions	800 mm
Diameter Ø	33 mm
Material	Polyalu
Gross weight	0.993 kg
Packaging	Printed plastic protection bag
Maximum Weight Capacity	150 kg
Laboratory tests	225 kg
Made in France	yes
Maintenance	yes

Guarantee	10 years
Gencod	3563390461853
Custom code	7615200000
Technical sheet	A55035800_IND_06
Spare parts	Ref. 046100, Polyalu cover plate. Ref. 046101, Bag of 3 stainless steel screws. Ref. 046288, Flange, cover plate and fixings.

Fixing and maintenance advices

Recommended height for the horizontal part : 800 mm from the ground. Grab bars provide support and added safety if properly fitted in accordance with our technical instructions. Careful consideration and selection of the appropriate wall fixings according to the wall-mounted support is required to ensure the long life of your accessory. The use of stainless steel screws (Ø 4 mm) is highly recommended to prevent corrosion in damp environment. Before drilling, physically hold the product against the wall at desired position and mark the hole locations. All the fixing points must be respected. After installation and before use, make sure that all fixing screws are tightened securely. **DO NOT** use the grab bar as a step. **DO NOT** sit on or hang from the grab bar.

Fiche produit mise à jour le : 07/05/2024