

Product data sheet

Information

Designation	90° angled curtain rail, 1150 x 800 mm, Chrome and nickel-plated Brass, tube Ø 16 mm
Reference	004115

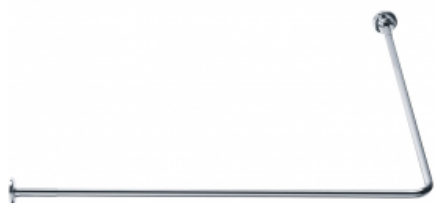

Product advantages

- + Corrosion resistant warranty.

Description

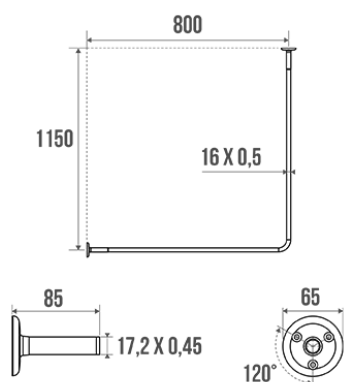

Tube Ø 16 x 0,5 mm.
Can be cut to size.
2 long sliding wall flanges.

Wall fixings not included.

Technical characteristics

Finish	Chrome and nickel-plated
Dimensions	1150 x 800 mm
Material	Brass
Gross weight	0.540 kg
Packaging	Printed plastic protection bag
Made in France	yes
Maintenance	yes
Guarantee	10 years
Gencod	3563390041154
Custom code	7418200090
Technical sheet	No technical sheet available
Spare parts	Ref. 004151, Wall flange.

Fixing and maintenance advices

Careful consideration and selection of the appropriate wall fixings according to the wall-mounted support is required to ensure the long life of your accessory. The use of stainless steel screws (\varnothing 4 mm) is highly recommended to prevent corrosion in damp environment. Before drilling, physically hold the product against the wall at desired position and mark the hole locations. All the fixing points must be respected. After installation and before use, make sure that all fixing screws are tightened securely.

Fiche produit mise à jour le : 07/05/2024