

Product data sheet

Information

Designation	Quarter-circle curtain rail, 800 x 800 mm, Chrome and nickel-plated Brass, tube Ø 16 mm
Reference	004433

Product advantages

- + Corrosion resistant warranty.

Description

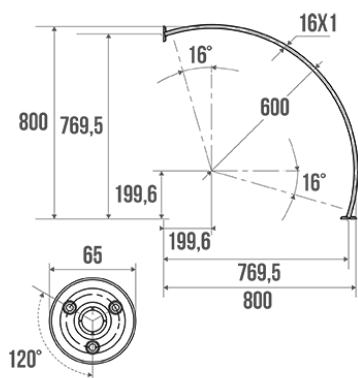

Tube Ø 16 x 1 mm.
Minimum curtain width : 1400 mm 1400 mm.
Cannot be shortened.
2 welded flanges.

Wall fixings not included.

Technical characteristics

Finish	Chrome and nickel-plated
Dimensions	800 x 800 mm
Diameter Ø	16 mm
Material	Brass
Gross weight	0.660 kg
Packaging	Plastic protection bag
Made in France	yes
Maintenance	yes
Guarantee	10 years
Gencod	3563390044339
Custom code	7418200090
Technical sheet	No technical sheet available

Fixing and maintenance advices

Careful consideration and selection of the appropriate wall fixings according to the wall-mounted support is required to ensure the long life of your accessory. The use of stainless steel screws (\varnothing 4 mm) is highly recommended to prevent corrosion in damp environment. Before drilling, physically hold the product against the wall at desired position and mark the hole locations. All the fixing points must be respected. After installation and before use, make sure that all fixing screws are tightened securely.

Fiche produit mise à jour le : 07/05/2024