

Product data sheet



Information

Designation	Straight grab bar, 300 mm, White & Red Epoxy-coated Aluminium, tube Ø 30 mm
Reference	049132



Product advantages

- + Invisible fasteners.
- + Anti-corrosion guarantee.

Description

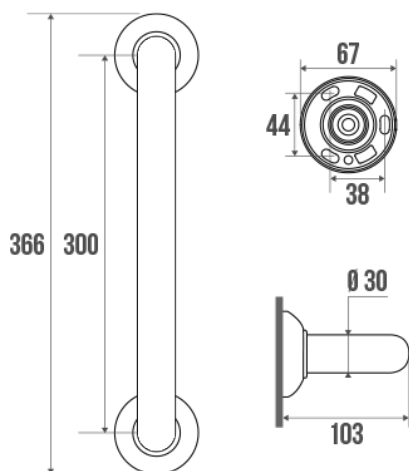

Concealed fixings.
White epoxy-coated aluminium tube Ø 30 mm.
Red (RAL 3003) resin flanges Ø 65 mm.

Possibility to fix the toilet roll holder ref. 048820 to this bar.
Design coordinated with the TRIOLO Range accessories.
Fixing screws included (4 x 30 mm).

Technical characteristics

Finish	Epoxy-coated
Color	White & Red
Dimensions	300 mm
Diameter Ø	30 mm
Material	Aluminum
Gross weight	0.410 kg
Packaging	Plastic protection bag + Hanger for display
CE Marking : safe load	150 kg
Laboratory tests	225 kg
Made in France	yes

Maintenance	yes
Guarantee	10 years
Gencod	3563390491324
Custom code	7615200000
Technical sheet	A49130137_IND_07

Fixing and maintenance advices

Recommended height for the horizontal part : 800 mm from the ground. Grab bars provide support and added safety if properly fitted in accordance with our technical instructions. Careful consideration and selection of the appropriate wall fixings according to the wall-mounted support is required to ensure the long life of your accessory. The use of stainless steel screws (\varnothing 4 mm) is highly recommended to prevent corrosion in damp environment. Before drilling, physically hold the product against the wall at desired position and mark the hole locations. All the fixing points must be respected. After installation and before use, make sure that all fixing screws are tightened securely. DO NOT use the grab bar as a step. DO NOT sit on or hang from the grab bar.

Fiche produit mise à jour le : 09/03/2023