

Product data sheet



Information

Designation ARSIS straight grab bar, 800 mm, White Epoxy-coated Aluminium
Reference 049880



Product advantages

- + Elliptic tube for an improved grip.
- + Elegant and Design.
- + Corrosion resistant warranty.

Description

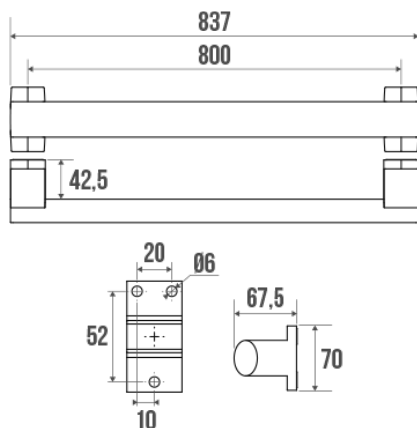

Elliptical tube in white epoxy-coated aluminium 38 x 25 mm.
White resin cover plates.

Wall fixings included.
Design coordinated with all ARSIS Comfort items.
Perfectly suitable for use in the hospitality industry.

Technical characteristics

Finish	Epoxy-coated
Color	White
Dimensions	800 mm
Diameter Ø	38 x 25 mm
Material	Aluminum
Gross weight	0.760 kg
Packaging	Plastic protection bag + Hanger for display
CE Marking : safe load	120 kg
Laboratory tests	180 kg
Made in France	yes

Maintenance	yes
Guarantee	10 years
Net weight	0.665 kg
Gencod	3563390498804
Custom code	7615200000
Technical sheet	A04984002_IND_11
Spare parts	Réf. 049007 : Support de fixation alu chromé, Réf. 049008 : Cache-fixation blanc

Fixing and maintenance advices

Recommended height for the horizontal part : 800 mm from the ground. Grab bars provide support and added safety if properly fitted in accordance with our technical instructions. Careful consideration and selection of the appropriate wall fixings according to the wall-mounted support is required to ensure the long life of your accessory. The use of stainless steel screws (\varnothing 4 mm) is highly recommended to prevent corrosion in damp environment. Before drilling, physically hold the product against the wall at desired position and mark the hole locations. All the fixing points must be respected. After installation and before use, make sure that all fixing screws are tightened securely. **DO NOT** use the grab bar as a step. **DO NOT** sit on or hang from the grab bar.

Fiche produit mise à jour le : 07/05/2024